

DATECH

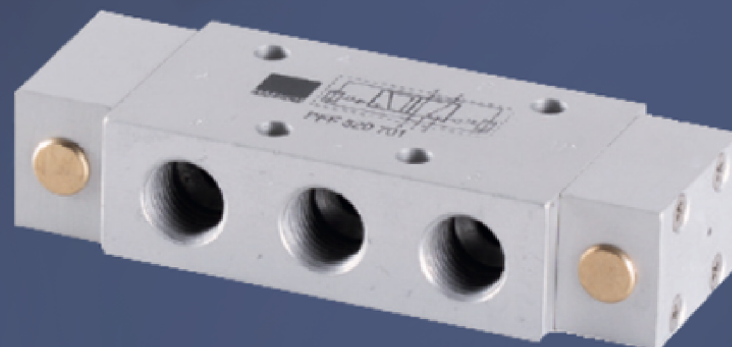
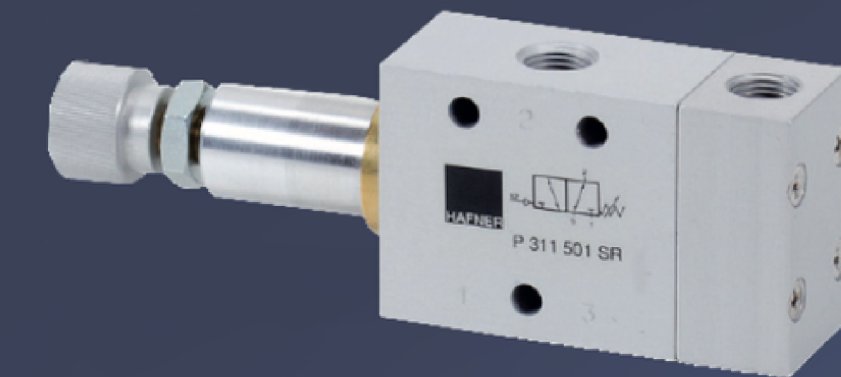

FONCTIONS SPÉCIALES

SÉRIE
PSR / PFF

FONCTIONS SPÉCIALES

SÉRIE

P...SR

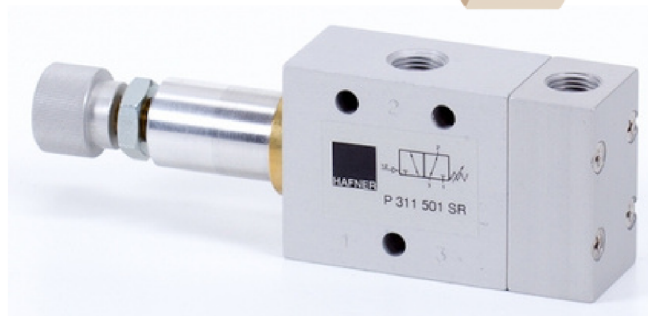

G 1/8"

P 311 501 SR

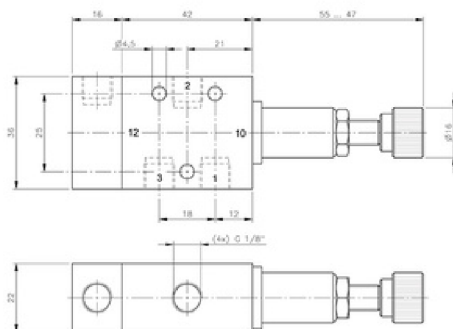
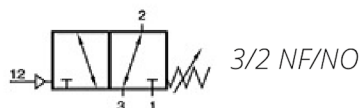

G 1/4"

P 411 701 SR

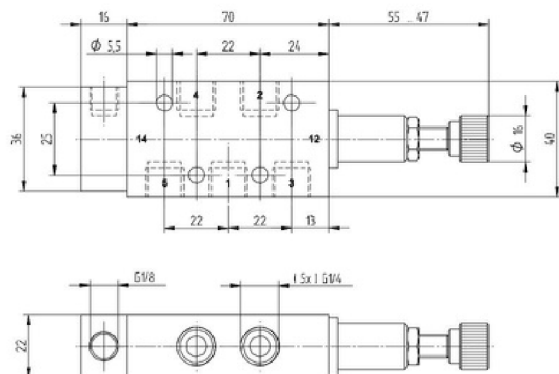

Référence	Orifice	Débit	Pression	Pression de réglage	Poids
P 311 501 SR	G 1/8"	650 l/min	1 - 10 bars	3-6 bar	0,04 kg
P 311 501 SR 02	G 1/8"	650 l/min	1 - 10 bars	5-8 bar	0,04 kg
P 311 501 SR 03	G 1/8"	650 l/min	1 - 10 bars	2-4 bar	0,04 kg
P 411 701 SR	G 1/4"	1250 l/min	1 - 10 bars	3-6 bar	0,04 kg

FONCTIONS SPÉCIALES

SÉRIE
PFF / PFFR



G 1/4"

PFF 520 701

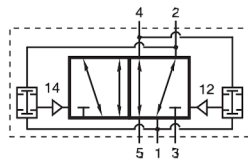

Oscillateur

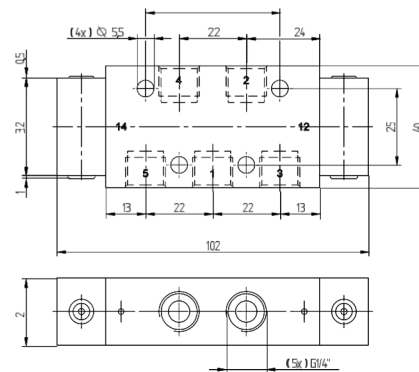

PFFR 520 701

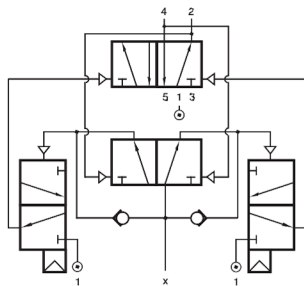

Oscillateur

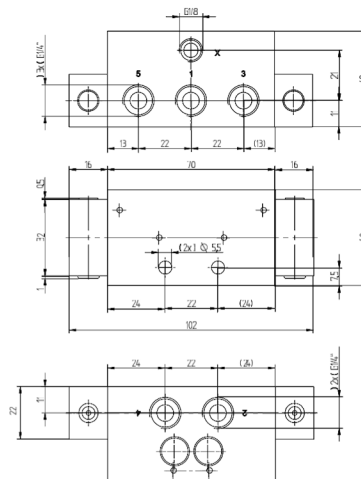

Référence	Orifice	Débit	Pression	Poids
PFF 520 701	G 1/4"	1250 l/min	2 - 10 bars	0,22 kg
PFFR 520 701	G 1/4"	1250 l/min	2 - 10 bars	0,40 kg